

## Product information sheet SOLIS 450-U

Item no. 526120

### Benefits

---



- A harmonious interplay between functional and visual elements
- High-quality features with covered C-overflow and InFino strainer system
- Convenient bowl volume and base surface designed for optimum use
- Functional accessories optionally available

## Planning information

---

- Cut out information supplied with bowls.<br>Cut out CNC files also available on [www.blanco.co.uk](http://www.blanco.co.uk) for download.

## Scope of supply

---

- waste kit with space-saving pipe
- 3 ½" InFino basket strainer
- fixing kit

## Details

---

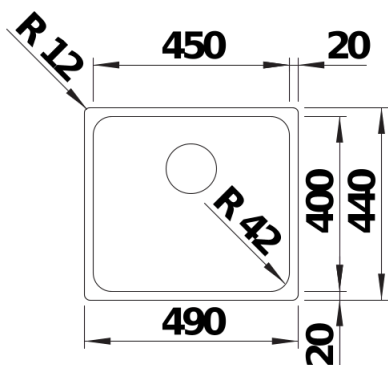

Top view

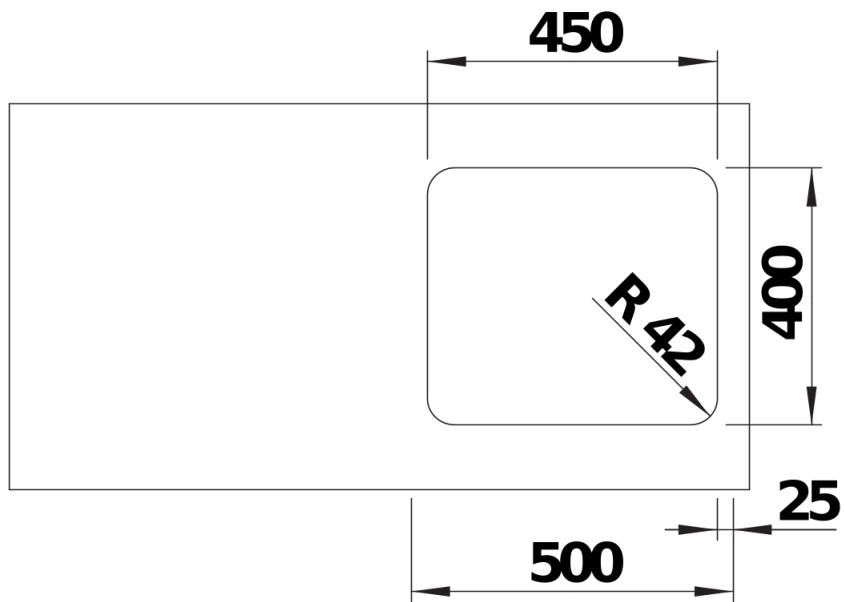

Cut-out

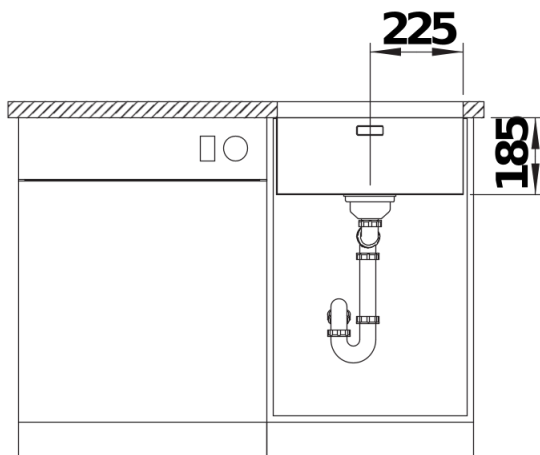

Front view

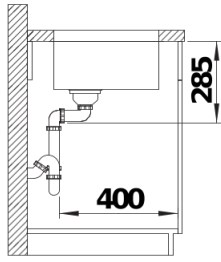

Side view